

COMPLETE THE CABLE PART NUMBER IN THE BOX

B188-

HUB 1 SEE PAGE 2	HUB 2 SEE PAGE 2	STRAND END 1 SEE PAGE 3	SPRING END 1 <i>leave blank for no spring</i> SEE PAGE 4	STRAND END 2 SEE PAGE 3	SPRING END 2 <i>leave blank for no spring</i> SEE PAGE 4	STRAND LENGTH	CONDUIT LENGTH
------------------------	------------------------	-------------------------------	---	-------------------------------	---	---------------	----------------

NOTE
When measuring a cable make sure it is laying straight. Bends in a cable can change how far the strand sticks out of each end.

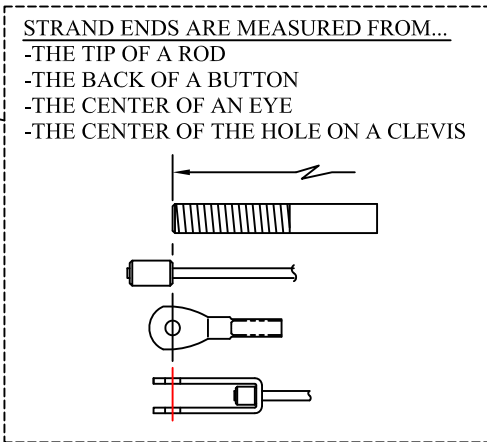
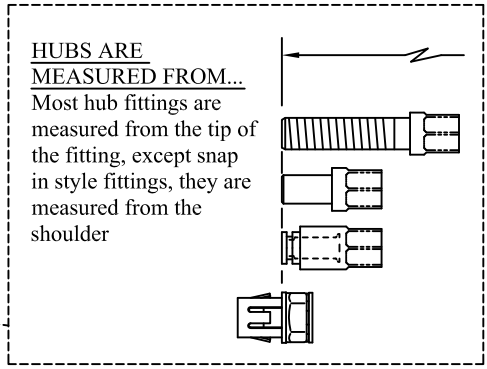

PART NUMBER EXAMPLE

The cable shown here is a... B188- B H 01 u 11 - 61.25 / 52.5

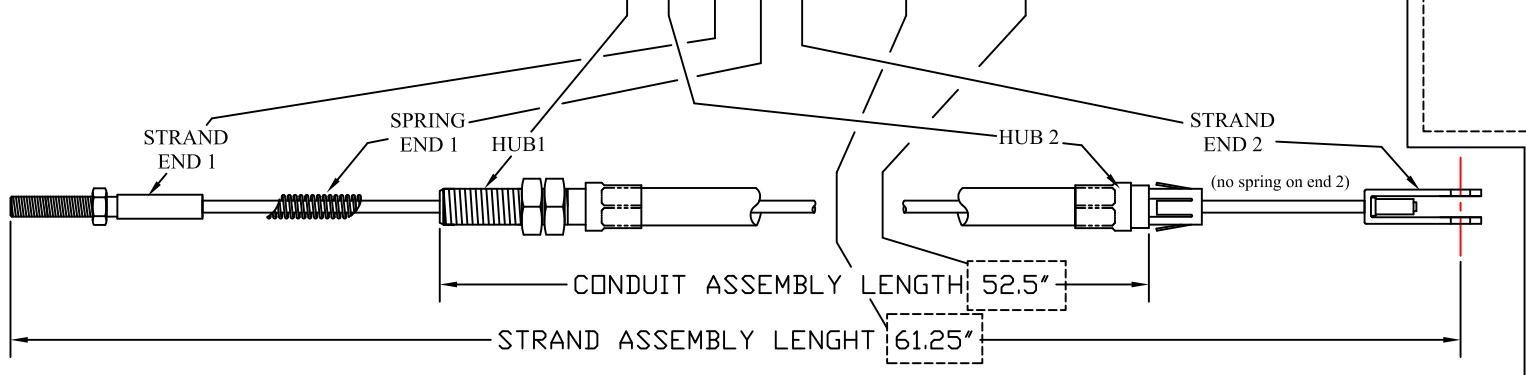

NAME: _____

ADDRESS: _____

PHONE: _____

SIGNATURE: _____

BY SIGNING I APPROVE THE MEASUREMENTS ON THIS DRAWING, AND UNDERSTAND THAT THIS CUSTOM CABLE IS NON-RETURNABLE

3/16" BRAKE CABLE IS RATED FOR 2,000 lbs PULL LOAD

Revisions
Rel-



6019 CR 77 - Millersburg, OH 44654 - (330) 893-0242

3/16" BRAKE CABLE ORDER SHEET

Drawn: JWY	Date: 3/21/2020	Drawing Number	Rev
Sim to:		B188-BRAKE CABLE	Rel

Page 1 of 4

PAGE 2 - 3/16" BRAKE HUBS

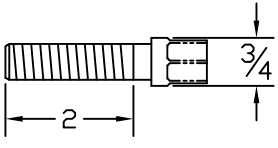
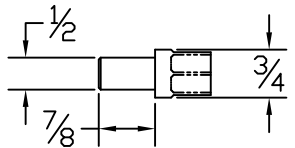
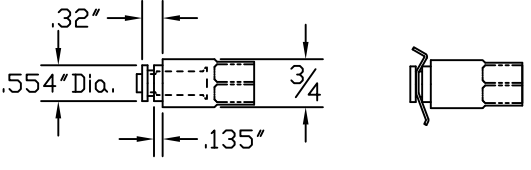
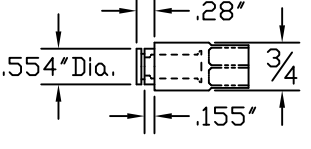
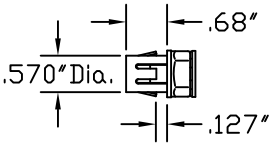
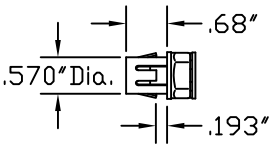
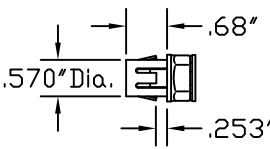
HUB LETTER	DRAWING	DESCRIPTION
B		BULKHEAD HUB 9/16-12 THREAD (INCLUDES 2 JAMB NUTS)
C		CLAMP HUB 1/2" DIA.
D		SPRING CLIP HUB (INCLUDES SPRING CLIP)
E		E-RING HUB (INCLUDES E-RING)
H		SNAP IN HUB For .575-.580" Dia. hole in 1/8" plate
I		SNAP IN HUB For .575-.580" Dia. hole in 3/16" plate
J		SNAP IN HUB For .575-.580" Dia. hole in 1/4" plate



6019 CR 77 - Millersburg, OH 44654 - (330) 893-0242

3/16" BRAKE CABLE ORDER SHEET

Drawn: JWY	Date: 3/21/2020	Drawing Number	Rev
Sim to:		B188-BRAKE CABLE	Rel
			Page 2 of 4

PAGE 3 - 3/16" STRAND FITTINGS

FITTING LETTER	PICTURE	DESCRIPTION
01		ROD 5/16-24, 1-1/2" LONG THREAD, 3" LONG
02		ROD 5/16-24, 2-1/4" LONG THREAD, 3-3/4" LONG
03		ROD 3/8-24, 1-1/2" LONG THREAD, 2-5/8" LONG
04		ROD 3/8-24, 2-1/2" LONG THREAD, 3-5/8" LONG
05		BUTTON, FLAT, 3/8" Dia x 7/8" LONG
06		BUTTON, RADIUS, .355" Dia. x 5/8" LONG
26		SWAGE EYE, 1/4" PIN, 1/2" WIDE, 3/16" THICK
24		SWAGE EYE, 1/4" PIN, 3/4" WIDE, 1/4" THICK
08		SWAGE EYE, 5/16" PIN, 3/4" WIDE, 1/4" THICK
09		SWAGE EYE, 3/8" PIN, 3/4" WIDE, 1/4" THICK
10		SWAGE EYE, 1/2" PIN, 3/4" WIDE, 1/4" THICK
11		CLEVIS, 5/16" PIN, 3/8" x 1-1/2"
12		CLEVIS, 5/16" PIN, 3/8" x 1-5/8"
13		CLEVIS, 5/16" PIN, 3/8" x 2"
25		CLEVIS, 5/16" PIN, 1/2" x 1-1/2"
14		CLEVIS, 5/16" PIN, 1/2" x 1-7/8"
15		CLEVIS, 5/16" PIN, 1/2" x 2"
16		CLEVIS, 3/8" PIN, 3/8" x 1-5/8"
17		CLEVIS, 3/8" PIN, 3/8" x 2"
18		CLEVIS, 3/8" PIN, 1/2" x 1-15/16"
19		CLEVIS, 3/8" PIN, 1/2" x 2"
20		CLEVIS, 5/16" PIN, 3/16" x 1-9/16"
21		CLEVIS, 5/16" PIN, 1/4" x 1-3/4"
22		CLEVIS, 5/16" PIN, 1/4" x 2-3/8"
23		CLEVIS, 3/8" PIN, 1/4" x 2-3/8"









6019 CR 77 - Millersburg, OH 44654 - (330) 893-0242

3/16" BRAKE CABLE ORDER SHEET

Drawn: JWY	Date: 3/21/2020	Drawing Number	Rev
Sim to:		B188-BRAKE CABLE	Rel
			Page 3 of 4

PAGE 4 - SPRINGS

u		SPRING, 7.75" FREE LENGTH, 2.88" COMPRESSED, 5.3 POUNDS PER INCH
v		SPRING, 10.50" FREE LENGTH, 3.50" COMPRESSED, 5.0 POUNDS PER INCH
w		SPRING, 10.00" FREE LENGTH, 3.50" COMPRESSED, 4.7 POUNDS PER INCH
x		SPRING, 5.00" FREE LENGTH, 1.38" COMPRESSED, 5.5 POUNDS PER INCH
y		SPRING, 5.30" FREE LENGTH, 2.75" COMPRESSED, 11.5 POUNDS PER INCH
z		SPRING, 5.00" FREE LENGTH, 2.25" COMPRESSED, 11.5 POUNDS PER INCH



6019 CR 77 - Millersburg, OH 44654 - (330) 893-0242

3/16" BRAKE CABLE ORDER SHEET

Drawn: JWY	Date: 3/21/2020	Drawing Number	Rev
Sim to:		B188-BRAKE CABLE	Rel
			Page 4 of 4